

Warmup

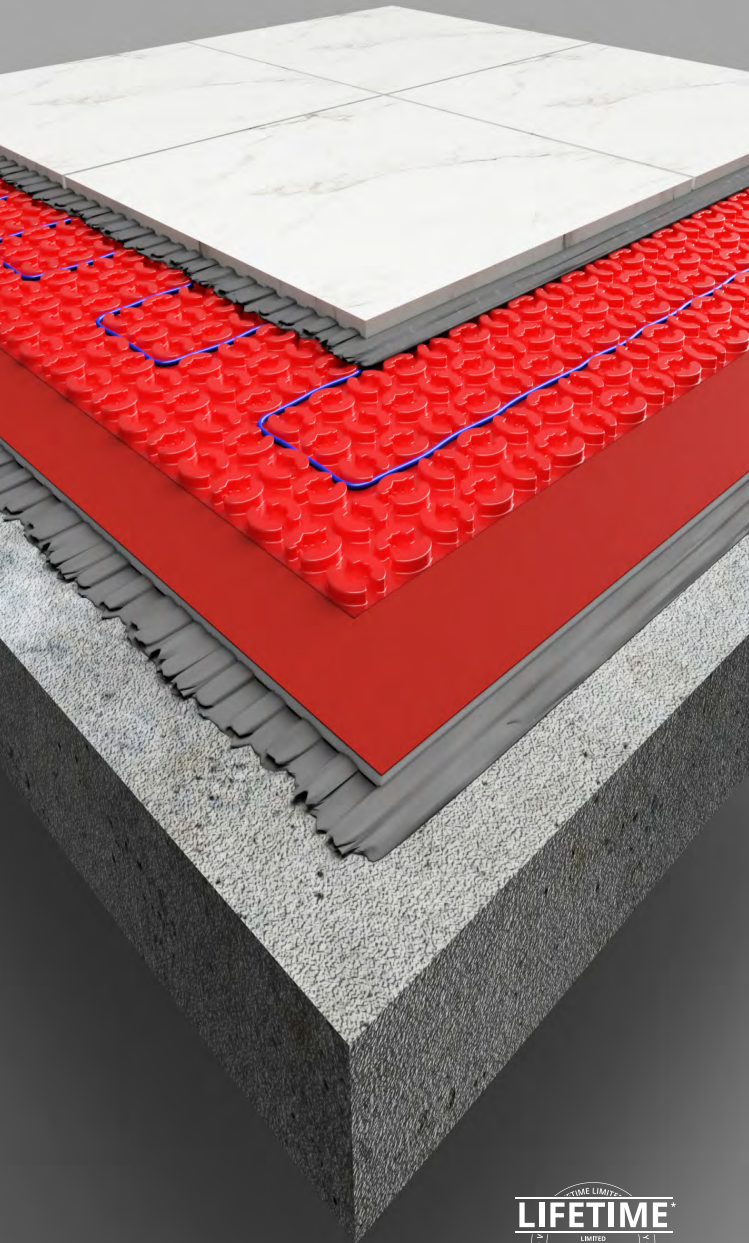

Warmup DCM-PRO
Installation manual

SAFETY NetTM
Installation-Guarantee



Warmup[®]

The world's best-selling floor heating brand[™]

Over 2.7 million installations
in more than 72 countries

Experience MyHeating[™]

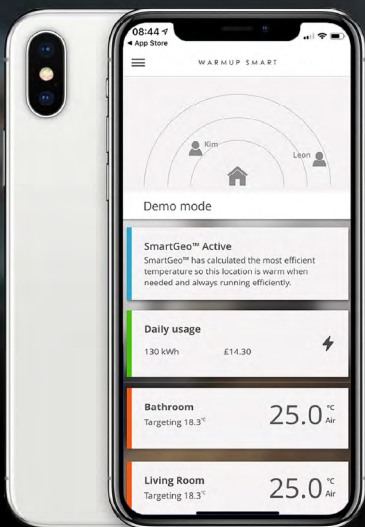

SmartGeo[™]

Unique SmartGeo[™] automatically turns down the heating when you're out.



Easy to use

Simple and secure setup using WiFi, with 24/7 technical support.



AutoSwitch[™]

Always on the best tariff, automatically. **Reduce energy bills by over £400**

Download now for iOS and Android



6iE OB WiFi Thermostat



Table of Contents

Safety information	4
Installation summary	6
Components available from Warmup	9
Step 1 - Electrical supply	10
Typical floor build-ups	12
Tile floor finishes - Peel and Stick	12
Tile floor finishes - Fleece	13
All floor finishes - Fleece	14
Step 2 - Subfloor considerations	15
Step 3 - Subfloor preparation	16
Step 4 - Layout planning	17
Step 5 - DCM PRO installation	20
Waterproofing	23
Step 6 - Select floor covering	24
Step 7 - Lay the Floor Covering	26
- Tile floor finishes	26
- All Floor Finishes	27
Step 8 - Connect the thermostat	28
- Connect the thermostat (Load exceeding 16 Amps)	29
Troubleshooting	30
Performance troubleshooting	32
Testing information	34
Technical specifications	36
System performance	38
Warranty	40
Control card	41
EcoDesign compliance information card	42
SafetyNet Installation Guarantee	43















Your Warmup heating system has been designed so that installation is quick and straight forward, but as with all electrical systems, certain procedures must be strictly followed. Please ensure that you have the correct heating cable(s) for the area you wish to heat. Warmup plc, the manufacturer of the Warmup DCM-PRO System, accepts no liability, expressed or implied, for any loss or consequential damage suffered as a result of installations which in any way contravene the instructions that follow.

It is important that before, during and after installation that all requirements are met and understood. If the instructions are followed, you should have no problems. If you require help at any stage, please contact our helpline.















You may also find a copy of this manual, wiring instructions and other helpful information on our website:

www.warmup.co.uk

Safety information

-  Perform a site inspection. You will need to confirm that all measurements and other requirements on site match your working drawings.
-  Inspect the site for possible hazards that could damage the heating cable, such as nails, staples, materials or tools. Ensure that during the course of the installation no damage is caused to the heating cable by falling or sharp objects.
-  Ensure all electrical connections conform to the current BS 7671 National Wiring Regulations. Final connections to the main electricity supply MUST be completed by a Part P qualified electrician.
-  Ensure the system is protected by a dedicated 30 mA RCD/RCBO or an existing RCD/RCBO). Time delay RCD's must not be used.
-  Ensure the Control card, EcoDesign compliance card at the back of the manual, layout plan, and all electrical test records are completed and affixed to the consumer unit, following the current BS 7671 standards.
-  The subfloor must be pre-insulated unless it is an intermediate floor. Ensure the subfloor is prepared to an SR1 Surface Regularity. The subfloor must be smooth, dry, frost-free, solid, suitably weight-bearing and dimensionally stable.
-  Ensure suspended timber subfloors are prepared in accordance with national standards and that manufacturer instructions are properly followed to avoid subfloor movement to prevent any damage to the system.
-  Install the floor sensor centrally between two closest parallel runs of heating cable and away from other heat sources such as hot water pipes, lighting fixtures, chimneys etc.
-  Before installing the floor finish, its suitability for use with underfloor heating and its maximum operating temperature should be checked against required operating conditions. Ensure the heat output of the floor meets your requirements.
-  Install floor coverings which are at least 5 mm thick. For floor coverings other than tile, lay a minimum 10 mm levelling compound over the heating cable first. Check with flooring manufacturer for suitability with floor heating.
-  Ensure adhesives, grouts, levelling compound used is compatible with underfloor heating and suitable for application onto electric underfloor heating systems and non-porous underlayments such as DCM-PRO.
-  Underfloor heating performs the most efficiently with conductive, low resistance floor finishes such as stone and tiles. Consideration should be given to the thermal resistance and temperature limits of the chosen floor covering and its impact on the system heat output.
-  Ensure all furniture installed over underfloor heating has feet, creating a minimum 50 mm ventilated space beneath it to allow heat flow into the room.
-  This heater incorporates an earth connection for functional purposes only.
-  This appliance can be used by children aged from 8 years and above and persons with reduced physical, sensory or mental capabilities or lack of experience and knowledge if they have been given supervision or instruction concerning use of the appliance in a safe way and understand the hazards involved. Children shall not play with the appliance. Cleaning and user maintenance shall not be made by children without supervision.

Safety information

-  The coldtail can be cut / extended where required. This heating cable has a type Y coldtail attachment, therefore if the coldtail is damaged, it must be replaced by the manufacturer, its service agent or similarly qualified persons in order to avoid a hazard.
-  DO NOT store the Peel and Stick mat in direct sunlight. Prolonged exposure to UV radiation will alter the properties of the adhesive backing, voiding the product warranty.
-  DO NOT install the Peel and Stick mat on coarse or loose subfloors. If necessary an appropriate levelling compound should be applied to the subfloor or DCM-PRO Fleece mat should be installed.
-  Levelling compounds must be suitable for single pour installation depths of at least 10 mm to 15 mm, measured from the top and bottom of the castellations respectively.
-  DO NOT cut, shorten or extend the heating cable, it must be fully installed within the layer of tile adhesive or levelling compound. The heating cable must not be installed over another cable run, over coldtails or the floor sensor.
-  DO NOT leave surplus heating cable rolled up under units or fixtures, use the correct size system for your installation.
-  DO NOT attempt a DIY repair if you damage the heating cable, contact Warmup for assistance.
-  DO NOT tape over manufactured joints or the sensor tip. Doing so will cause air pockets and damage the heating cable and sensor. The manufactured joints and heater must be covered with a full bed of flexible adhesive directly beneath the heated floor.
-  DO NOT install items above the heating system which have a combined resistance of more than 0.15 m²K/W. Such items include bean bags, heavy rugs, flat furniture, animal beds or mattresses.
-  DO NOT bend the heating cable under 25 mm radius.
-  DO NOT switch on the system until the tile adhesive and grout has fully cured. DO NOT use the heating cable to accelerate the drying process of the adhesive or levelling compound.
-  DO NOT install the heating cable in temperatures less than - 10 °C.
-  DO NOT install the system on irregular surfaces such as on stairs or up walls.
-  DO NOT use staples to secure the heating cable to the subfloor.
-  DO NOT install mats in locations where they will increase the ambient temperature of any existing electrical installation above its rated value.

Symbols used in manual

WARNING! Radiant direct floor heating system.

Risk of shock or fire

Failure to comply with local wiring regulations or the contents of this manual may result in electric shock or fire!



Installation in concrete or similar material



Important information



Installation summary

Please also read the full instructions that follow this section.



- Make electrical provision for the system (30 mA RCD, overcurrent protection, 35 mm deep electrical back boxes, trunking).



- The subfloor must be pre-insulated unless it is an intermediate floor. Ensure the subfloor is prepared to an SR1 surface regularity. The subfloor must be smooth, dry, frost-free, solid, suitably weight-bearing and dimensionally stable.
- Referring to its instructions, prime the subfloor using Warmup primer.



- We recommend installing Warmup Ultralight for optimum performance referring to its instructions.
- If you plan to self-level over the DCM-PRO system, install perimeter strip around the perimeter of the room to allow for differential movement between finished floor level and walls.

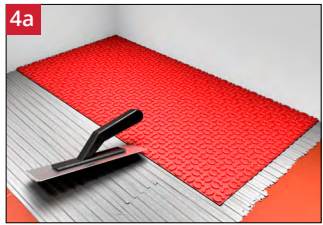

- If installing DCM-PRO Fleece mat apply a layer of flexible tile adhesive to the substrate using a notch trowel.
- Cut the mat to size and press into the tile adhesive using a float or roller, removing any air pockets.
- Lay additional sheets as above ensuring the castellations are aligned.

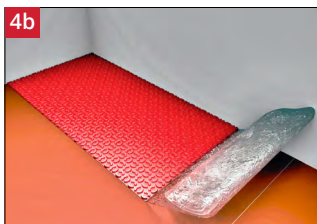

- If installing DCM-PRO Peel and Stick, cut mat to size, peel off backing and stick in place pressing down once aligned.
- Lay additional sheets as above ensuring the castellations are aligned.

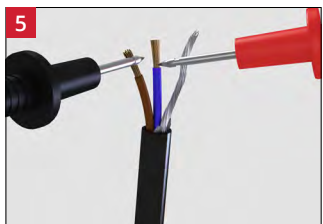

- Test the resistance of the heating cable ensuring it is within the range set out in the Reference Resistance Band table.

Installation summary

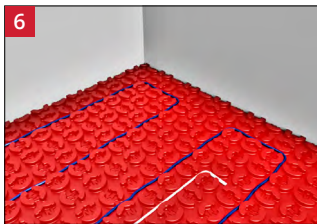

- Install the heating cable at the chosen spacing, minimum 60 mm.
- Maintain a perimeter spacing of half the chosen cable spacing
- Install the floor sensor centrally between two closest parallel runs of heating cable.

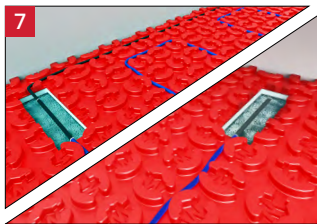

- Channel a groove in the subfloor for the coldtail & termination joints, enabling them to fit flush with the top of the system.

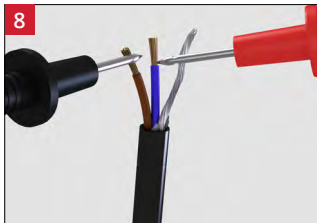

- Test the resistance of the heating cable after installation and check against the previous value to ensure no damage has occurred.

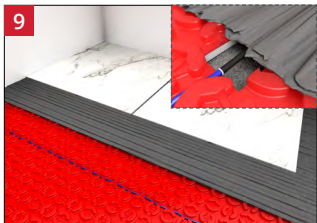

- Lay tiles or levelling compound over the system.
- The system, including its joints, must be wholly within the adhesive or levelling compound and not exposed.

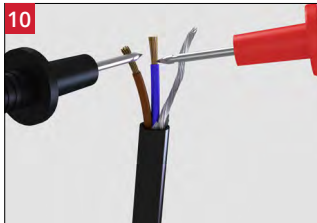

- Test the resistance of the system after tiling and check against previous values to ensure no damage has occurred.



- Install your Warmup thermostat referring to their installation instructions. The system must be connected to and controlled with a thermostat and sensor.

Warmup DCM-PRO



Warmup DCM-PRO Low wattage cable

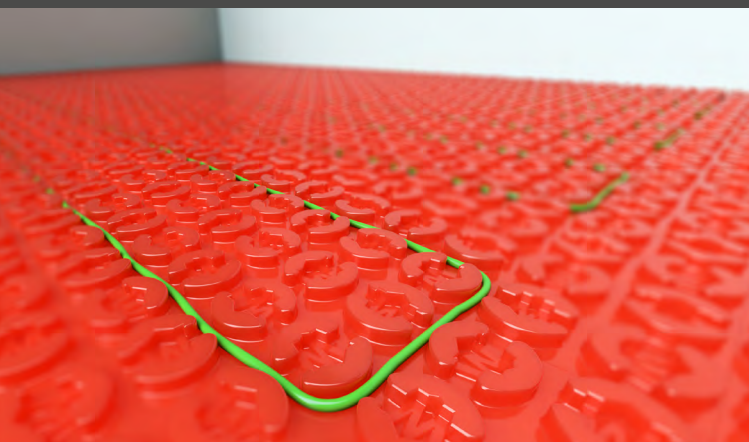

Warmup DCM-PRO is an electric underfloor heating system designed for use within tile adhesive beneath tiles or within a levelling compound for other floor finishes.

The DCM-PRO range consists of two decoupling mat versions, into which the DCM-PRO heating cable is installed; a peel and stick version that is ideal for use over Warmup Ultralight and smooth surfaces and a fleece backed version that is ideal for use over coarser or damp surfaces.

The DCM-PRO cable is available in standard and low power versions, allowing for the installed power to be set from 41.25 to 225W/m² to match the system requirements. At the standard 3 castellation spacing, the low power version produces 55W/m² making it ideal for heating modern low energy homes. For older homes with higher heat loss, or for installations where a warmer floor is desired, the standard power version which produces 150W/m² when installed at a 3 castellation spacing is still probably the best choice.

Components available from Warmup

Product Code	Description
DCM-C-X DCM-C-LW-X	DCM-PRO cable DCM-PRO low wattage cable
DCM-PS-X DCM-F-X	DCM-PRO Peel and stick mat DCM-PRO Fleece mat
DCM-E-25	Perimeter strip
DCM-T-X	Waterproofing tape
DCM-R-I	Internal waterproofing corner
DCM-E-I	External waterproofing corner
WCI-6 / WCI-16	Warmup Ultralight
6iE-01-OB-DC 6iE-01-BP-LC	Warmup 6iE
RSW-01-WH-RG (ELM-01-WH-RG) RSW-01-OB-DC (ELM-01-OB-DC)	Warmup Element
ELT PW (ELT-01-PW-01) ELT PB (ELT-01-PB-01)	Warmup tempo
ACC-PRIMER	Warmup primer
ACC-SELFLEVEL	Mapei Ultraplan Renovation Screed 3240. Fibre reinforced levelling compound

Additional components that may be required as part of your Warmup heating installation:

30 mA Residual Current Device (RCD/RCBO), required as part of all installations

Overcurrent protection, such as MCB's, RCBO's or fuses

Electrical housing, back boxes and junction boxes

Electrical trunking/conduit for housing the power leads

Digital multi-meter required for testing the resistance of the heating cable and sensor

Electrical tape to secure the sensor

Step 1 - Electrical supply

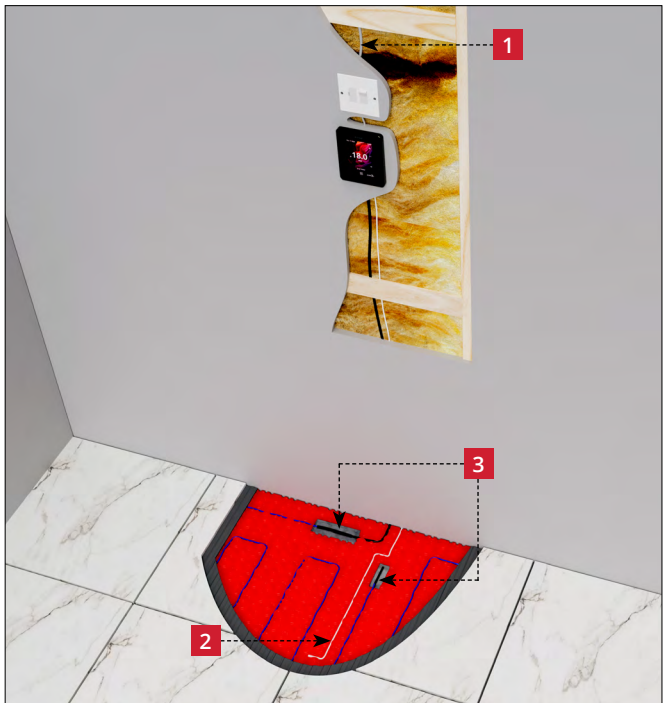

- 1** The supply to the thermostat **MUST** be protected by a 30mA RCD or RCBO at all times. Time delay RCD's or RCBO's must not be used. No more than 7.5 kW of heating should be connected to each 30 milliamp RCD or RCBO. For larger loads, use multiple RCD's or RCBO's.

The heating cable must be separated from the power supply by suitably rated circuit breaker that disconnects all poles with at least 3 mm contact separation. Use MCB's, RCBO's or fuses for this purpose.

Final connections to the main electricity supply **MUST** be completed by a qualified electrician.

- 2** Sensor installed (300 mm) centrally between two closest parallel runs of heating cable and away from other heat sources such as hot water pipes, lighting fixtures etc.
- 3** Manufactured joints recessed into subfloor so as they sit at the same height as the heater.

i If taking the power supply to the heaters from an existing 30 mA RCD/RCBO protected circuit, it should be calculated whether or not the circuit can handle the additional load and if necessary the supply must be de-rated to ≤ 16 amps.

i A junction box is required if more than two heaters are being connected to a single Warmup thermostat.

i When conducting an insulation resistance test on the supply to the thermostat the thermostat and heaters must be isolated or disconnected.

Step 1 - Electrical supply



Zoning information

In the case of bathroom installations, electrical regulations prohibit the installation of mains voltage products such as thermostats, contactors, fused spurs, isolators or junction boxes, within Zones 0 or 1.

Any mains voltage product fitted within Zone 2 must have a degree of protection at least of IPX4 or IPX5 if water jets are present.

It is common to install the thermostat outside of wet rooms in the adjacent connected room in circumstances where it is not practical to install the thermostat within the wet room.

When installed in this way, using only the sensor to control the heating, it is not possible to directly control the air temperature, only the surface temperature.

 All electrical connections must conform to the current BS 7671 National Wiring Regulations. Final connections to the main electricity supply MUST be completed by a Part P qualified electrician.

Typical floor build-ups

Tile floor finishes - Peel and Stick

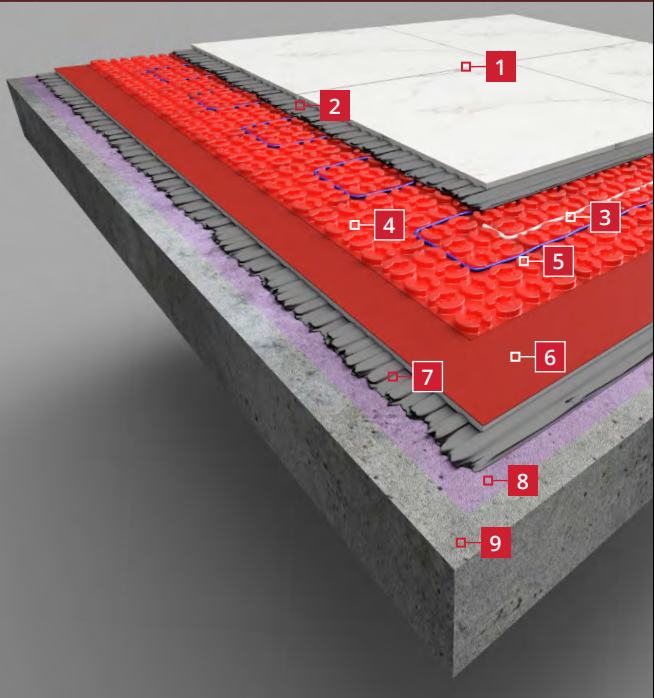

1	Tile Floor finish
2	Flexible tile adhesive
3	Floor sensor <i>Tab tape the sensor to the subfloor. Do not tape over the sensor tip!</i>
4	DCM-PRO Peel & Stick mat <i>Apply pressure to the mat to ensure a secure bond to the subfloor</i>
5	Heating cable <i>DO NOT cut at any stage!</i>
6	Warmup Ultralight (Optional) <i>Adding Warmup Ultralight below DCM-PRO can help improve the response time of the system, particularly when installing over screed or concrete</i>
7	Flexible tile adhesive (Optional) <i>Required if installing Warmup Ultralight</i>
8	Warmup primer <i>Refer to tile adhesive manufacturers instructions for priming requirements</i>
9	Pre-insulated subfloor with a surface regularity of SR1*

* If installing the optional Warmup Ultralight, refer to its installation manual for its subfloor requirements.

Typical floor build-ups

Tile floor finishes - Fleece

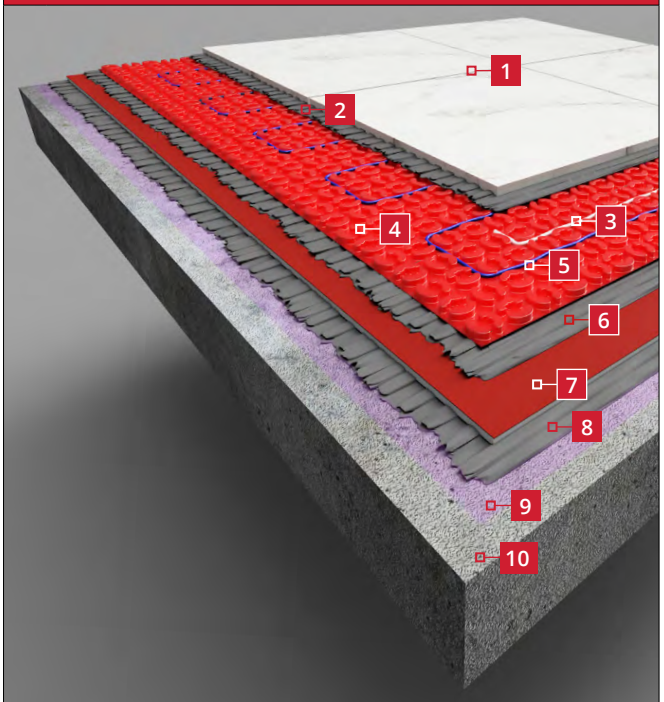

1	Tile Floor finish
2	Flexible tile adhesive
3	Floor sensor <i>Tab tape the sensor to the subfloor. Do not tape over the sensor tip!</i>
4	DCM-PRO Fleece mat <i>Apply pressure to the mat to ensure a secure bond to the adhesive</i>
5	Heating cable <i>DO NOT cut at any stage!</i>
6	Flexible tile adhesive
7	Warmup Ultralight (Optional) <i>Adding Warmup Ultralight below DCM-PRO can help improve the response time of the system, particularly when installing over screed or concrete</i>
8	Flexible tile adhesive (Optional) <i>Required if installing Warmup Ultralight</i>
9	Warmup primer <i>Refer to tile adhesive manufacturers instructions for priming requirements</i>
10	Pre-insulated subfloor with a surface regularity of SR1*
* If installing the optional Warmup Ultralight, refer to its installation manual for its subfloor requirements.	

Typical floor build-ups

All floor finishes

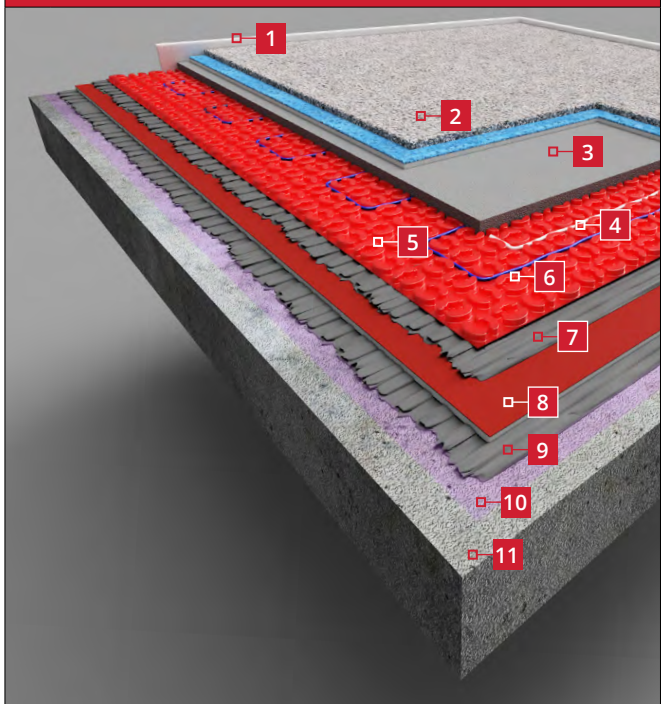

- | | |
|----|--|
| 1 | Perimeter strip
<i>To allow for differential movement between finished floor level and walls</i> |
| 2 | Floor finish |
| 3 | 10 mm levelling compound
<i>Levelling compound used must be compatible with electric underfloor heating. The levelling compound must be applied as a single layer.</i> |
| 4 | Floor sensor
<i>Tab tape the sensor to the subfloor. Do not tape over the sensor tip!</i> |
| 5 | DCM-PRO Fleece Mat
<i>Apply pressure to ensure a secure bond</i> |
| 6 | Heating cable
<i>DO NOT cut at any stage!</i> |
| 7 | Flexible tile adhesive |
| 8 | Warmup Ultralight (Optional)
<i>Adding Warmup Ultralight below DCM-PRO can help improve the response time of the system, particularly when installing over screed or concrete</i> |
| 9 | Flexible tile adhesive (Optional)
<i>Required if installing Warmup Ultralight</i> |
| 10 | Warmup primer
<i>Refer to tile adhesive manufacturers instructions for priming requirements</i> |
| 11 | Pre-insulated subfloor with a surface regularity of SR1* |





* If installing the optional Warmup Ultralight, refer to its installation manual for its subfloor requirements.

Step 2 - Subfloor considerations

To prevent excessive heat loss through the floor, DCM-PRO may only be laid over insulated or intermediate subfloors.

The subfloor must be solid, structurally sound and dimensionally stable. Ensure the subfloor is prepared to an SR1 surface regularity. If necessary an appropriate smoothing or levelling compound should be applied.

The surface DCM-PRO is being applied to must be smooth and primed with Warmup primer such that a clean and continuous bond can be made. Warmup primer requires that the subfloor is dry, frost-free, solid, weight-bearing and dimensionally stable. It must be free from contaminants that may impede adhesion such as dust, dirt, oil, grease, release agents, loose material or surface laitance.

-  Subfloors previously covered in vinyl, cork or carpeting: all old flooring and glues must be removed.
-  Any materials on or within the subfloor must be suitable for supporting electric underfloor heating systems. If using temperature sensitive materials beneath DCM-PRO, such as damp proofing or tanking systems, contact the manufacturer for advice.
-  If installing DCM-PRO over Warmup Ultralight, the surface of the Ultralight does not need priming if it is kept clean.
-  Where ceramic tiles are to be used, ensure that the subfloor meets the Tile Associations minimum specifications. Timber subfloors should be prepared for tiling in accordance with local tiling standards such as BS 5385-3.
-  Do not commence installation of the DCM-PRO without ensuring that the resulting floor construction will meet the requirements of the floors intended use and its finish.

DCM-PRO mat selection

To ensure you select the most suitable DCM-PRO mat for your application and subfloor use the decision tree below.

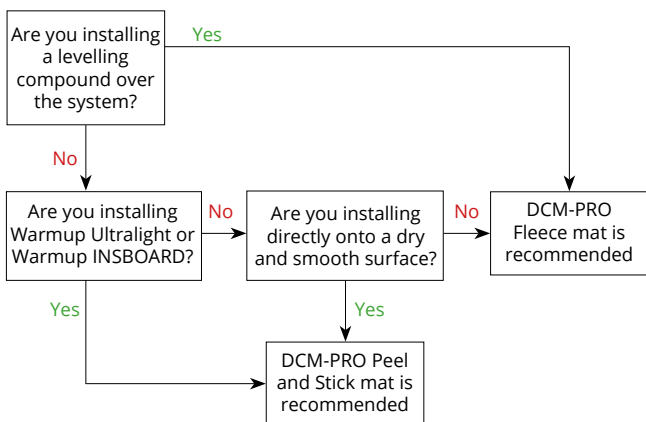

Step 3 - Subfloor preparation



- The subfloor must be pre-insulated unless it is an intermediate floor.
- Ensure the subfloor is prepared to an SR1 Surface Regularity.



- The subfloor must be smooth, dry, frost-free, solid, suitably weight-bearing and dimensionally stable.
- Referring to its instructions, prime the subfloor using Warmup primer.







- We recommend installing Warmup Ultralight for optimum performance referring to its instructions.
- If you plan to self-level over the DCM-PRO system, install perimeter strip around the perimeter of the room to allow for differential movement between finished floor level and walls.

Step 4 - Layout Planning

Cable layouts

In order to fit the cable into a specific area, it may be necessary to lay the heating cable around obstacles. Please refer to the examples below for guidance.

-  Take care not to cut or damage the heating cable.
-  Maintain a minimum of 60 mm between any heating cable.
-  Please take a moment to double-check that your plan has the proper room dimensions and that you have the correct length cable. Do not install under fixed objects such as kitchen or bathroom units.
-  When laying two or more systems, ensure all coldtails reach the thermostat.

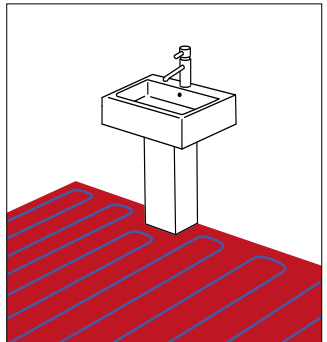
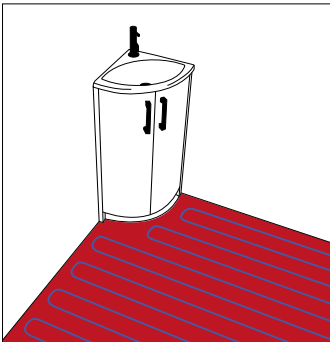
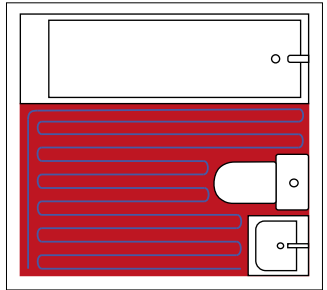
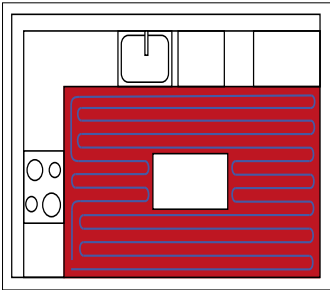
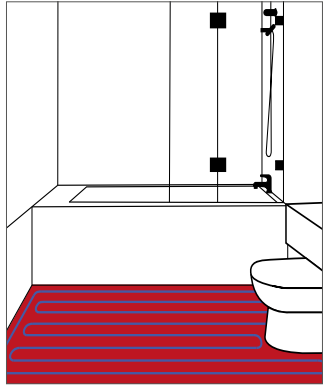
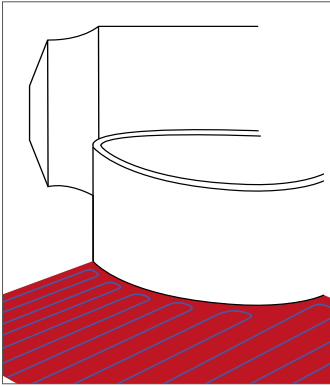

Step 4 - Layout planning

-  A plan of the heating cable layout is required as part of the control card so that any cutting or drilling after tiling will not result in injury or damage to the system.

Before you begin

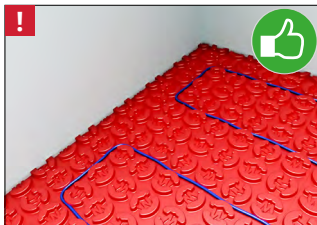

- When installing the cable, maintain a spacing of half its cable to cable spacing, between itself and the perimeter or any unheated areas.

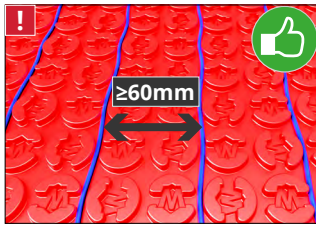

- Ensure that there is a minimum of 60 mm between any heating cable and that the cable is away from the influence of other heat sources, such as heating and hot water pipes, lighting fixtures or chimneys at all times.

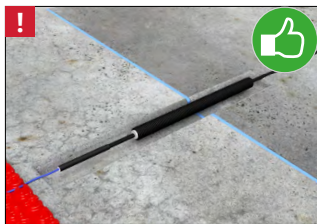

- Heating cables must not cross building expansion joints. If a heated floor is divided by expansion joints, use separate systems for each area. However, the coldtail can cross the joint within a 300 mm conduit.



- The heating cable must not be cut, shortened, extended or left in a void, it must be fully installed within the layer of tile adhesive.

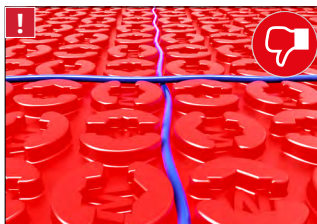

- When installing the system DO NOT cross the cable over another run, over coldtails or the sensor probe. This will cause overheating and will damage the cable.

-  The system should not be installed on irregular surfaces such as on stairs or up walls.

Step 4 - Layout Planning

Heated area at different spacings, m ²					
	Castellations				
	2	2/3	3	3/4	4
	60mm	60/90mm	90mm	90/120mm	120mm
DCM-C Heat output	225 W/m²	~ 180 W/m²	150 W/m²	~ 130 W/m²	112.5 W/m²
DCM-C-LW Heat output	82.5 W/m²	~ 66.0 W/m²	55.0 W/m²	~ 47 W/m²	41.3 W/m²
DCM-C-1 DCM-C-LW-1	0.7	0.8	1.0	1.2	1.3
DCM-C-1.5 DCM-C-LW-1.5	1.0	1.3	1.5	1.8	2.0
DCM-C-2 DCM-C-LW-2	1.3	1.7	2.0	2.3	2.7
DCM-C-2.5 DCM-C-LW-2.5	1.7	2.1	2.5	2.9	3.3
DCM-C-3 DCM-C-LW-3	2.0	2.5	3.0	3.5	4.0
DCM-C-3.5 DCM-C-LW-3.5	2.3	2.9	3.5	4.1	4.7
DCM-C-4 DCM-C-LW-4	2.7	3.3	4.0	4.7	5.3
DCM-C-4.5 DCM-C-LW-4.5	3.0	3.8	4.5	5.3	6.0
DCM-C-5 DCM-C-LW-5	3.3	4.2	5.0	5.8	6.7
DCM-C-6 DCM-C-LW-6	4.0	5.0	6.0	7.0	8.0
DCM-C-7 DCM-C-LW-7	4.7	5.8	7.0	8.2	9.3
DCM-C-8 DCM-C-LW-8	5.3	6.7	8.0	9.3	10.7
DCM-C-9 DCM-C-LW-9	6.0	7.5	9.0	10.5	12.0
DCM-C-10 DCM-C-LW-10	6.7	8.3	10.0	11.7	13.3
DCM-C-12 DCM-C-LW-12	8.0	10.0	12.0	14.0	16.0
DCM-C-14 DCM-C-LW-14	9.3	11.7	14.0	16.3	18.7
DCM-C-16 DCM-C-LW-16	10.7	13.3	16.0	18.7	21.3

Step 5 - DCM PRO installation

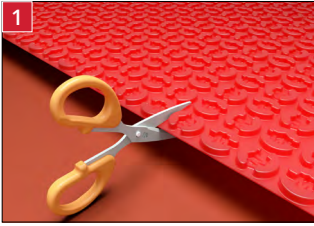

- Begin laying the mat by cutting to the size of your room using a utility knife or scissors.

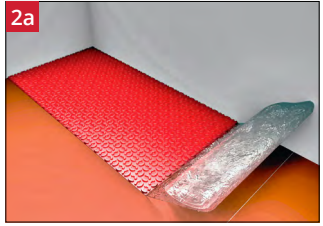

- If installing DCM-PRO Peel and Stick, position the mat and peel off the backing from the far corner or edge. Stick in place before removing the rest of the backing and press down to secure.

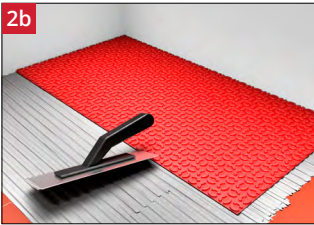

- If installing DCM-PRO Fleece mat apply a layer of tile adhesive to the substrate using a square notch trowel.
- Position the mat fleece side down and embed into the adhesive using a float or roller to remove any air pockets.

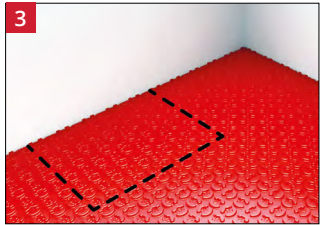

- Repeat previous steps for subsequent runs of the mat, ensuring the castellations are aligned and there are no gaps across the floor.
- Mark out the floor with a permanent marker showing where fixtures and other unheated areas are going to be.

Step 5 - DCM-PRO installation

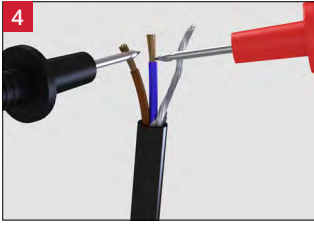

- Measure and record the resistance of the cable in the "Resistance Before" column of the control card, supplied as part of this installation guide.
- Stop installation immediately and contact Warmup if its resistance falls outside the range set out in the Reference Resistance Band table.

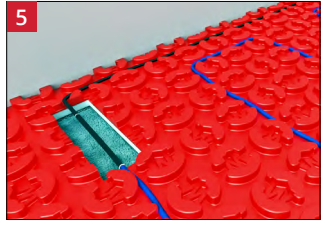

- Place the coldtail on the floor. Cut a section in the subfloor for the coldtail joint so that it sits at the same height as the system.
- Secure the coldtail using tabs of electrical tape as necessary.



DO NOT tape over the coldtail joint. It must be fully embedded within the tile adhesive or levelling compound being laid over.

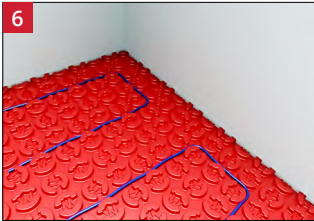

- Begin laying the heating cable, pressing it between the castellations.
- The heating cable should be evenly spaced to prevent thermal striping.
- **DO NOT** install the system in temperatures less than $-10\text{ }^{\circ}\text{C}$.

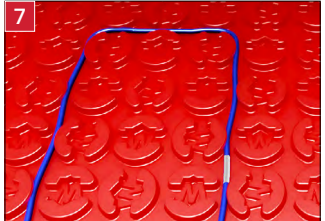

- The DCM-PRO cable has a marker at its midpoint. When you reach it, review your progress and check that you are correctly spacing the cable, ensuring that you will have covered the whole of the heated area when you reach the end of the cable.
- The length of cable remaining is also marked every meter along its length.



Ensure there is a minimum of 60 mm spacing between parallel heating cables.

Step 5 - DCM-PRO installation

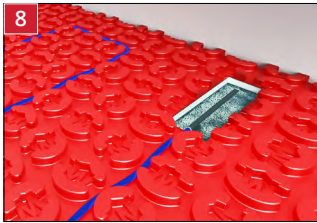

- At the end of the heating cable, you will find a termination joint.
- As with the coldtail joint at the beginning of the heating cable, this joint will have to be cut into the subfloor so that it sits at the same height as the system.



DO NOT tape over the termination joint. It must be fully embedded within the tile adhesive or levelling compound being laid over.

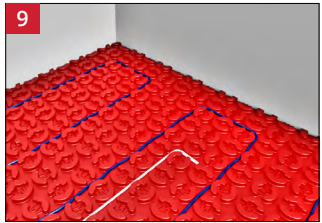

- Install the sensor at least 300 mm into the heated area it will be controlling. It should be located centrally between the two closest parallel runs of heating cable and not in an area influenced by other heat sources.
- The sensor can be secured to the subfloor with tabs of tape.



DO NOT tape over the sensor tip it must be in full contact with the heated tile adhesive or levelling compound.

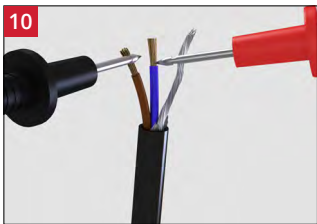

- Measure the resistance of the cable and verify it is still in line with the Resistance Before reading previously taken.
- Stop installation immediately and contact Warmup if its resistance has changed significantly or if it falls outside the range set out in the Reference Resistance Band table.

Waterproofing

Follow the steps below when using the Warmup DCM-PRO waterproofing products to waterproof the installation:

- i** If using a proprietary waterproofing system, a levelling compound should first be laid over the Warmup DCM-PRO system to provide a finished surface to install over.

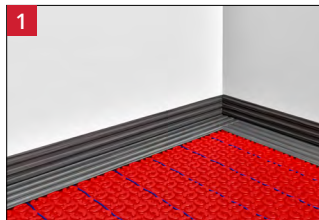

- Apply a waterproof adhesive that is suitable for use with underfloor heating to the mat, walls and 100 mm around any penetrations through the floor, ensuring there are no gaps or voids.

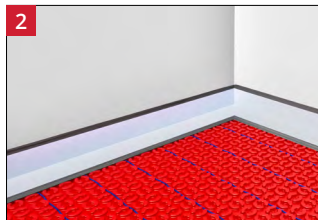

- Cut a length of Warmup waterproof tape to suit and press into the adhesive using a trowel, removing any air gaps or creases.

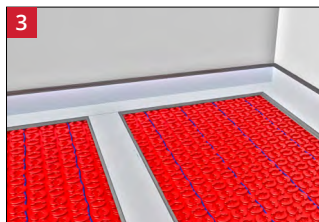

- To waterproof the joints between mat runs and over the cable joints, apply a layer of waterproof adhesive, 100 mm either side of the joint, making sure the cavities of the mat are fully filled.
- Cut a length of Warmup waterproof tape to suit and press into the adhesive removing any air gaps or creases with a trowel.

- i** Where joints are required, overlap the tape by 100 mm bonding the two lengths together with a layer of adhesive.

- i** At the manufactured joint, the termination joint or anywhere that the mat is damaged or pierced, cover the penetration with adhesive and a strip of Warmup waterproof tape.

Step 6 - Select floor covering



Before installing any floor finish, adhesive or levelling compound over DCM-PRO, the installation requirements of each must be checked to ensure compatibility with underfloor heating.

Tile floor finishes - Peel and Stick

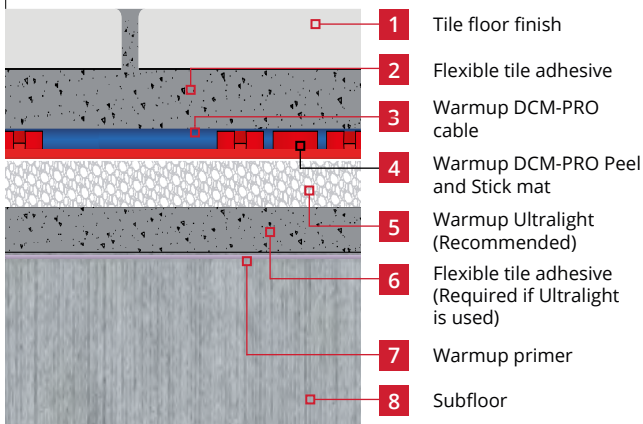



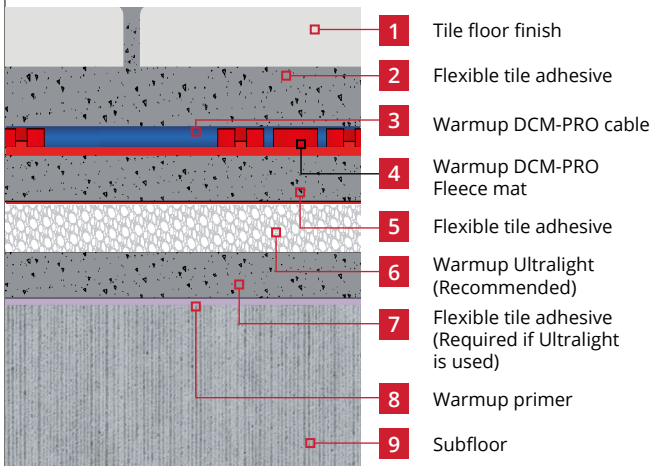

Tile floor finishes - Fleece



Step 6 - Select floor covering

If installing a leveller over DCM-PRO, you must ensure the leveller is:

-  Suitable for use over plastic membranes
-  Suitable for application depths across the range of 10-15mm
-  Mixed according to its instructions
-  Applied as a single full depth pour
-  Does not bridge expansion and contraction joints within the subfloor

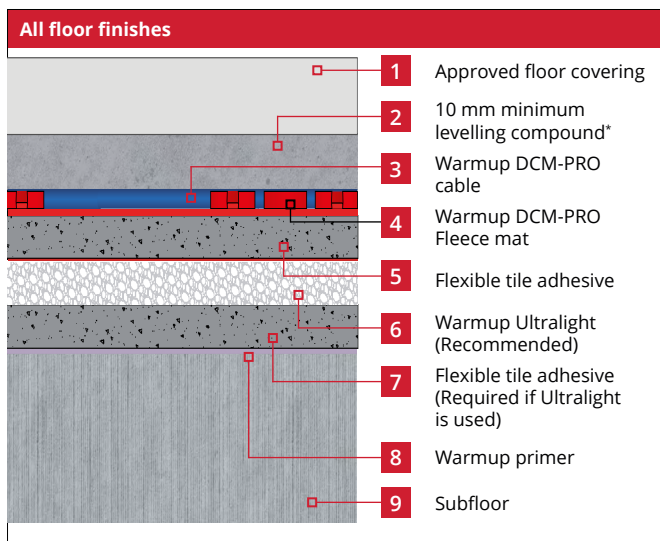

Failure to follow this manual's guidance or the installation instructions for the leveller may result in failure of the levelling compound.

If there is any doubt, seek advice.



* This method can be used to create a floor surface suitable for most floor finishes and when forming a drainage slope within a wetroom. The levelling compound, when used, must be applied as a single layer. Additional layers of levelling compound must not be added. Check with flooring manufacturer for suitability with floor heating.

Step 7 - Lay floor covering - Tile floor finishes

-  Underfloor heating performs the most efficiently with conductive, low resistance floor finishes such as stone and tiles. The maximum thermal resistance of the floor should not exceed 0.15 [m²K/W].
-  Ensure that the tile adhesive used is compatible with underfloor heating for application onto non porous materials such as the DCM-PRO mats.

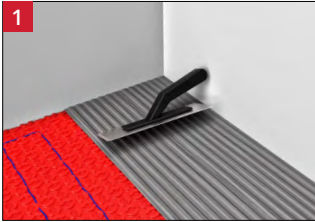

- Cover the installation with a full bed of flexible tile adhesive using a notched trowel. Take care not to damage or dislodge the heating cable. If using tiles smaller than 90 mm cover the installation with a levelling compound first.

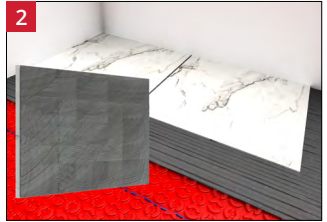

- Carefully lay the tiles and press into the adhesive bed. Remove the first tile and ensure the tile is getting a full coverage of adhesive from your application.
- Ensure the width of the grout line is in line with the manufacturers instructions for the size and type of tile being used. Tiles must not be removed once the adhesive has set, doing so will damage the system.



- Grout the floor as soon as possible as per the ceramic tile adhesive manufacturer's instructions.

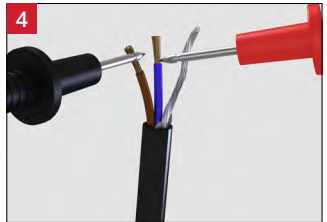

- When the tiles have been installed, conduct another resistance test to ensure the sensor and heating cable have not been damaged and record in the control card.



DO NOT switch on the system until the tile adhesive and grout has fully cured. DO NOT use the system to accelerate the drying process of the adhesive or levelling compound.

Step 7 - Lay floor covering - All floor finishes

- i** Before installing the floor finish its suitability for use with underfloor heating and its maximum operating temperature should be checked against required operating conditions.

If installing a leveller over DCM-PRO, you must ensure the leveller is:

- i** Suitable for use over plastic membranes
- i** Suitable for application depths across the range of 10-15mm
- i** Mixed according to its instructions
- i** Applied as a single full depth pour
- i** Does not bridge expansion and contraction joints within the subfloor

Failure to follow this manual's guidance or the installation instructions for the leveller may result in failure of the levelling compound.

If there is any doubt, seek advice.

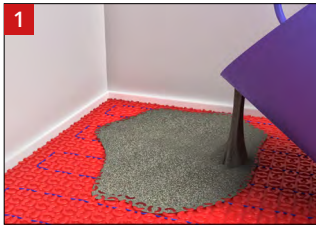

- If you are planning to install wood, carpet or vinyl over the system, a single layer of self levelling compound is required (**minimum thickness: 10 mm**) over the system. You must ensure that the heating cable, including joints are completely covered. It is important that the levelling compound is suitable for use with the underfloor heating.

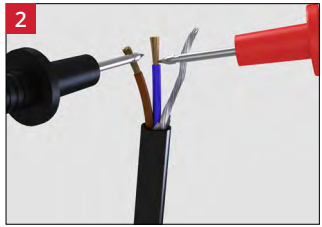

- When the levelling compound has been installed, conduct another resistance test to ensure the sensor and heating cable have not been damaged and record in the control card.



- The 30 mm tall perimeter strip should finish just proud of the levelling compound but can be trimmed back flush with a utility knife if required.

Step 8 - Connect the thermostat

i Install the thermostat in accordance with its installation instructions

Instructions for fitting Warmup® thermostats can be found inside the thermostat box. The thermostat should be connected to the main electrical supply by suitably rated circuit breaker that disconnects all poles with at least 3 mm contact separation. Use MCB's, RCBO's or fuses for this purpose.

The system power cable consists of conductors coloured brown (live), blue (neutral) and earth braid. If you are installing more than one heating cable a junction box will be required. Final connections to the main electricity supply **MUST** be completed in accordance with the wiring regulations by a qualified electrician.

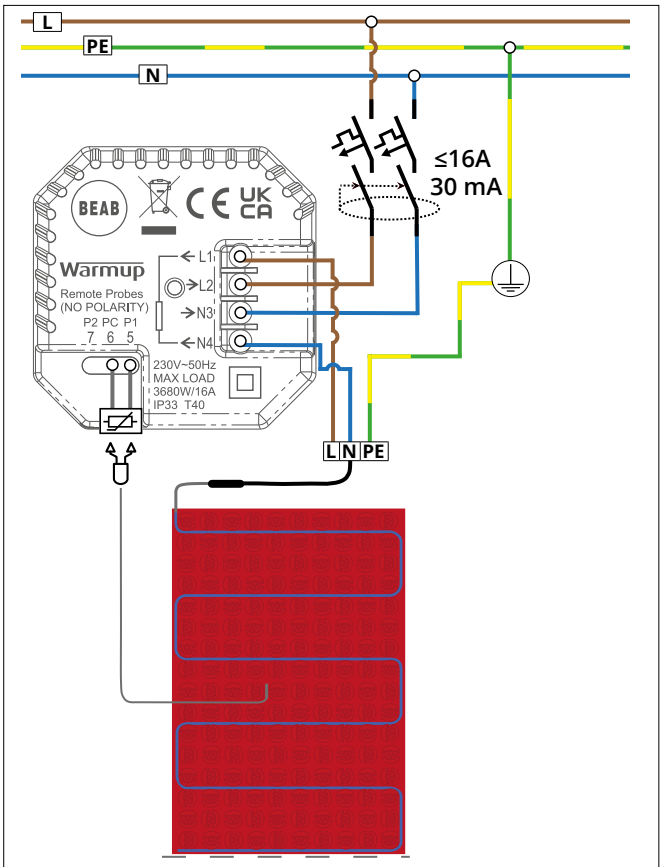

Step 8 - Connect the thermostat (Load exceeding 16 Amps)

Warmup thermostats are rated for a maximum of 16 amps (3680 W at 230 V). A contactor must be used to switch loads exceeding 16 amps.

If using contactors which exceed 16 amps, the supply to the heating cable(s) must be de-rated using fused spur(s) ≤ 16 Amps to provide overcurrent protection. Please see wiring diagram below.

 Thermostat wiring with a contactor must be completed by a qualified electrician.

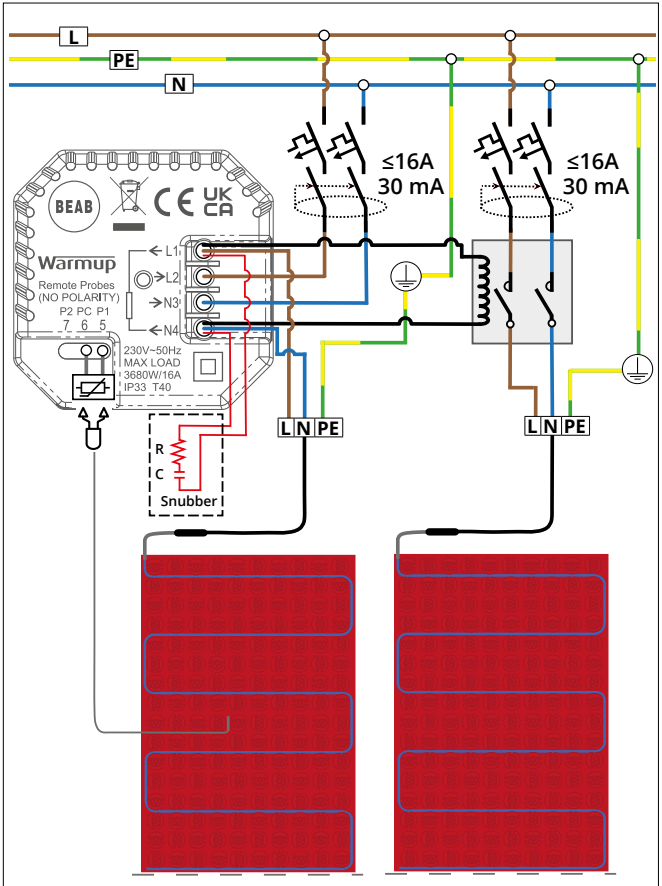

Troubleshooting

HEATING ISSUE 1 - The floor does not heat up

Instructions which are shaded must be completed by a qualified electrician

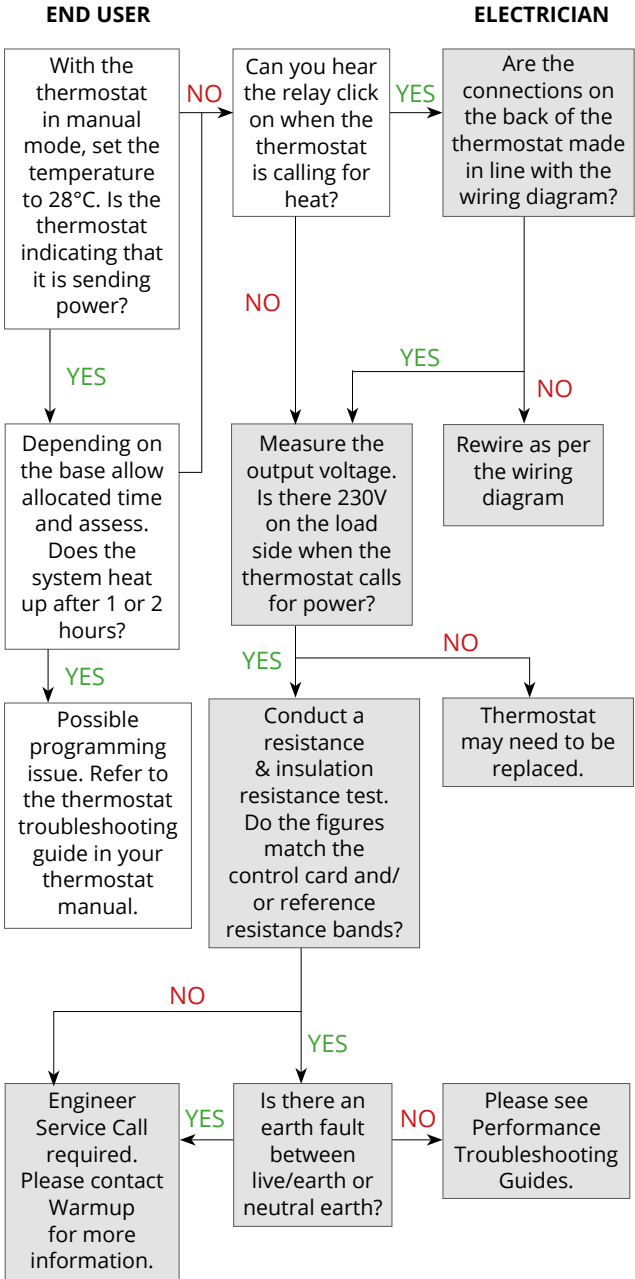

HEATING ISSUE 2 - The heating cable trips the RCD

Instructions which are shaded must be completed by a qualified electrician

ELECTRICIAN

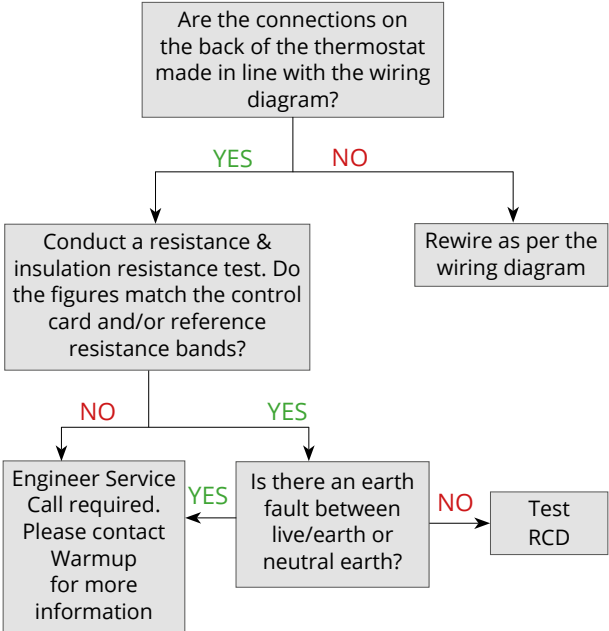





ISSUE 1 - My floor is getting too hot

PROBLEM		SOLUTION
1	The floor temperature settings on the thermostat may be incorrect.	Check the thermostat settings ensuring that it is controlling the floor surface temperature and that the set target and limiting temperatures are correct.
2	The floor sensor may be poorly positioned, if so the thermostat will be displaying a floor temperature that is not indicative of the floor surface temperature.	Recalibrate the floor sensor in the thermostat settings.
3	The thermostat may be set in regulator mode with the duty cycle set too high.	If the thermostat cannot be set to reference a floor sensor, reduce the regulation value to its minimum selectable value. With the heating active, incrementally increase the setting at an hourly interval until the required floor surface temperature is achieved.

ISSUE 2 - My floor does not get up to temperature

PROBLEM		SOLUTION
1	Underfloor heating is normally designed to heat floors to up to 9 °C above the design room air temperature, which is typically 29°C. Delicate floor finishes, such as vinyl and some timbers, may be limited to 27 °C. Our hand and foot temperature is normally similar to this, at around 29 - 32 °C, so the heated floor will feel slightly cooler than touching your own hands together.	If you wish to raise the floor temperature, such that it feels warm, it is permissible to set it up to 15 °C higher than the design room air temperature. The higher heat output of the floor may overheat the room, making it uncomfortable. The manufacturer of the floor finish should be consulted to ensure compatibility with the chosen temperature before making any changes to the thermostat settings.
	Refer to points 1, 2 & 3 in the “My floor is getting too hot” above, as each issue can also be the cause of under heating a floor.	
2	If the thermostat is controlling the heating using the air temperature, with a floor temperature limit then the floor may be turned off before it reaches its limit.	This is normal as the thermostat is preventing the room air temperature from becoming overheated.
3	The heating system may be uninsulated. If the system has not been installed over a layer of insulation, it will be actively heating the subfloor as well as the floor finish. The warm up period of the floor will therefore be slower as the system is heating a much greater mass. It could take several hours if it is installed directly on a thick layer of uninsulated concrete.	If your thermostat has an optimised start feature, ensure it is enabled so that the thermostat can compensate for the mass of the floor. If your thermostat does not have an optimised start feature, measure the time taken for the floor to warm up and adjust the heating start time to compensate.

Performance troubleshooting

4	<p>The heat output of the installed system may not be sufficient. The system will require a power output of approximately 10 W/m² for every degree warmer you require the floor to be than the air. This is in addition to any heat loss downwards through the subfloor</p>	<p>If the room air temperature is also lower than desired, supplementary heating may be required to overcome the room heat losses. If access is available to the underside of the subfloor, installing insulation within the floor will reduce the amount of heat lost through the floor.</p>
5	<p>Floor coverings such as carpets, underlays and timber are thermally resistive and will reduce the achievable floor surface temperature. They may also require the floor sensor to be recalibrated.</p>	<p>Floor finish combinations with a thermal resistance of more than 0.15 m²K/W or 1.5 tog are not recommended and we recommend that you look to fit a less resistive floor finish. Floor finish combinations with a thermal resistance of more than 0.25 m²K/W or 2.5 tog are not permitted.</p>
ISSUE 3 - I am getting patchy heat across my floor		
	<p>If the subfloor varies across the floor, the amount of heat absorbed by it and lost through it will affect the floor surface temperatures differently above each case.</p>	
	<p>If the floor covering over the underfloor heating changes, each floor finishes characteristics will affect the warm up period and the achievable surface temperature.</p>	
	<p>Hot water pipes under the floor could cause parts of the floor to seem warmer than others.</p>	
	<p>Irregularly spaced cables will cause the floor to be warmer above the closer cables and cooler where the cables are spaced further apart.</p>	

Testing information



Each heating cable and sensor must be tested before they are installed, once they have been laid but before tiling or laying levelling compound and again before they are connected to the thermostat. The resistance (ohms) should be measured and recorded in the control card at the end of the manual.



Due to the high resistance of the heating element, it may not be possible to get a continuity reading from the heating cable and as such, continuity testers are not an acceptable substitution for testing. When checking resistance, make sure your hands do not touch the meter's probes as the measurement will include your internal body resistance and render the measurement inaccurate. If you do not get the expected results or at any time you believe there may be a problem, please contact Warmup for guidance.

Heating cable resistance test

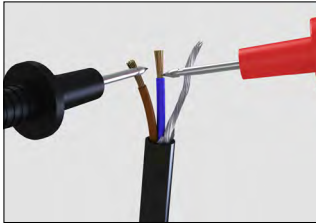

- Set a multimeter or ohmmeter to record resistance in the range of 0-500 Ω . Measure the resistance across the live (brown) and neutral (blue) wires. Ensure the measured resistance is within the Reference Resistance Band for the cable size being tested

Earth fault test

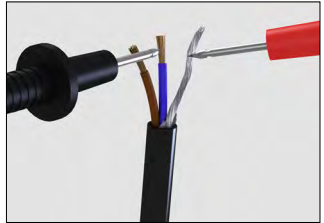

- Set a multimeter or ohmmeter to record resistance in the range of 1 M Ω or greater if available. Measure the resistance across the live (brown) and neutral (blue) wires to the earth braid. Ensure the measured resistance is showing as greater than 500 M Ω or infinite if the meter cannot read this high.
- Set an insulation resistance tester to 1000 V DC. Measure the resistance across the live (brown) and neutral (blue) wires to the earth braid wire. After 1 minute of application, ensure the measured resistance is showing greater than 50 M Ω to indicate a pass.

Testing information

Sensor resistance test

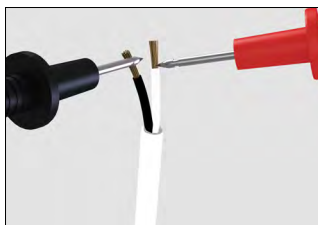

- Ensure that the sensor is tested before the final finish has been fitted. Warmup thermostats typically use a 10 k Ω sensor. Please refer to the thermostat manual for further details.



The expected resistance depending on temperature is listed below.

Sensor resistance by temperature - NTC10K

Temperature	Resistance	Temperature	Resistance
0 °C	32.8 k Ω	16 °C	15.0 k Ω
2 °C	29.6 k Ω	18 °C	13.7 k Ω
4 °C	26.8 k Ω	20 °C	12.5 k Ω
6 °C	24.2 k Ω	22 °C	11.4 k Ω
8 °C	22.0 k Ω	24 °C	10.5 k Ω
10 °C	19.9 k Ω	26 °C	9.6 k Ω
12 °C	18.1 k Ω	28 °C	8.8 k Ω
14 °C	16.5 k Ω	30 °C	8.1 k Ω

Technical specifications

DCM-PRO cable

Product code	DCM-C-X (<i>DCM-PRO</i>) DCM-C-LW-X (<i>DCM-PRO Low wattage</i>)
Operating voltage	230 V AC: 50 Hz
Protection	Class II 
Earth type	Functional earth  <i>Metal braiding surrounding heating cores</i>
Connection	3.0 m coldtail (2-core & earth)
Coldtail size	2Cx0.75 mm ² (Up to 6.0Amps) 2Cx1.0 mm ² (>6.0A to 10.0Amps) 2Cx1.5 mm ² (>10.0Amps)
IP rating	X7
Output rating	(3 castellations - 90 mm) DCM-C: 150 W/m ² ; DCM-C-LW: 55W/m ²
Heating cores	Dual core, multi-strand heating element
Inner / Outer insulation	ETFE / PVC
Cable sheath	Blue (<i>DCM-PRO</i>), Green (<i>DCM-PRO Low wattage</i>)
Cable thickness	4.5 mm

DCM-PRO mat

Product code	DCM-PS-X (Peel and Stick) DCM-F-X (Fleece)
Dimensions	Roll [14m ²] - 14,250mm (±50mm) x 985mm (±6mm) Mat [0.73m ²] - 985mm (±6mm) x 741mm (±6mm)
Thickness	Peel and Stick - 5.8 mm (±0.5mm) Fleece - 6.1 mm (±0.5mm)
Composition	Polypropylene mat with fleece / self-adhesive backing
Colour	Red
ANSI A118.12*	5.4 - System Crack Resistance Test DCM-PRO Fleece > 1/16" – Standard Performance DCM-PRO Peel and Stick > 1/8" – High Performance
ASTM C627*	Light Commercial Rating <i>[DCM-PRO fleece/peel and stick mat installed on Warmup Ultralight]</i>

* See the Warmup DCM-PRO technical specification sheet for full test results and floor constructions

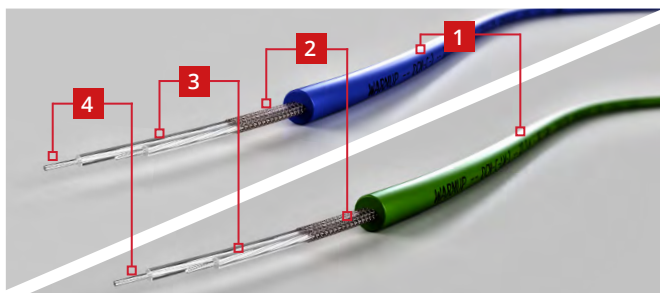

1	PVC outer insulation
2	Earth braiding surrounding heating cores
3	ETFE inner insulation
4	Dual core, multi-strand heating element

Technical specifications

DCM-PRO cable

Product code	Cable Length (m)	Power (W)	Current (A)	Resistance (Ω)	Resistance Band (Ω)		
DCM-C-1	10.9	150	0.7	352.7	335.0	-	370.3
DCM-C-1.5	16.3	225	1.0	235.1	223.4	-	246.9
DCM-C-2	21.8	300	1.3	176.3	167.5	-	185.1
DCM-C-2.5	27.2	375	1.6	141.1	134.0	-	148.2
DCM-C-3	32.7	450	2.0	117.6	111.7	-	123.5
DCM-C-3.5	38.1	525	2.3	100.8	95.7	-	105.8
DCM-C-4	43.5	600	2.6	88.2	83.8	-	92.6
DCM-C-4.5	49.0	675	2.9	78.4	74.5	-	82.3
DCM-C-5	54.4	750	3.3	70.5	67.0	-	74.0
DCM-C-6	65.3	900	3.9	58.8	55.8	-	61.7
DCM-C-7	76.2	1050	4.6	50.4	47.9	-	52.9
DCM-C-8	87.1	1200	5.2	44.1	42.0	-	46.3
DCM-C-9	98.0	1350	5.9	39.2	37.2	-	41.2
DCM-C-10	108.8	1500	6.5	35.3	33.5	-	37.1
DCM-C-12	130.6	1800	7.8	29.4	27.9	-	30.9
DCM-C-14	152.4	2100	9.1	25.2	23.9	-	26.5
DCM-C-16	174.1	2400	10.4	22.0	20.9	-	23.1

DCM-PRO Low Wattage Cable

Product code	Cable Length (m)	Power (W)	Current (A)	Resistance (Ω)	Resistance Band (Ω)		
DCM-C-LW-1	10.9	55	0.2	961.8	913.7	-	1009.9
DCM-C-LW-1.5	16.3	83	0.4	641.2	609.1	-	673.3
DCM-C-LW-2	21.8	110	0.5	480.9	456.9	-	505.0
DCM-C-LW-2.5	27.2	138	0.6	384.7	365.5	-	404.0
DCM-C-LW-3	32.7	165	0.7	320.6	304.6	-	336.6
DCM-C-LW-3.5	38.1	193	0.8	274.8	261.1	-	288.6
DCM-C-LW-4	43.5	220	1.0	240.5	228.4	-	252.5
DCM-C-LW-4.5	49.0	248	1.1	213.7	203.1	-	224.4
DCM-C-LW-5	54.4	275	1.2	192.4	182.7	-	202.0
DCM-C-LW-6	65.3	330	1.4	160.3	152.3	-	168.3
DCM-C-LW-7	76.2	385	1.7	137.4	130.5	-	144.3
DCM-C-LW-8	87.1	440	1.9	120.2	114.2	-	126.2
DCM-C-LW-9	98.0	495	2.2	106.9	101.5	-	112.2
DCM-C-LW-10	108.8	550	2.4	96.2	91.4	-	101.0
DCM-C-LW-12	130.6	660	2.9	80.2	76.1	-	84.2
DCM-C-LW-14	152.4	770	3.4	68.7	65.3	-	72.1
DCM-C-LW-16	174.2	880	3.8	60.1	57.1	-	63.1

Floor sensor setting for target heat output

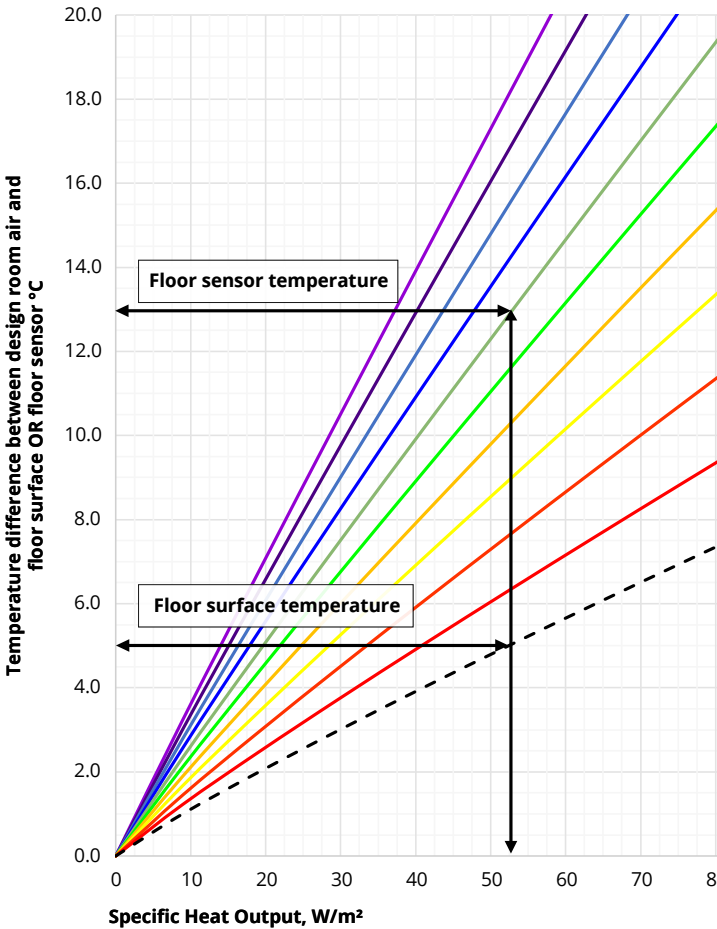

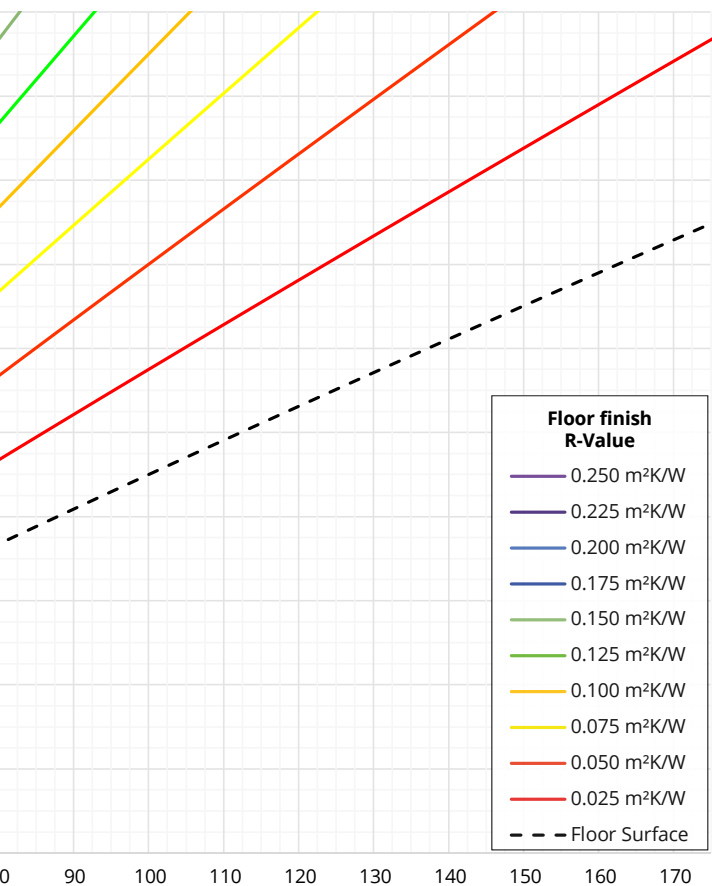

Using the graph above it is possible to get the specific heat output of an eUFH system based on the temperature difference between the design room air temperature and the floor surface or floor sensor temperature by floor finish.

The example above shows a design room air temperature of 20 °C and floor surface temperature of 25 °C. Based on the temperature difference of 5 °C the resulting heat output would be 52.5 W/m². Based on a 0.150 m²K/W (1.5 Tog) floor finish the floor sensor would have to be set to 33 °C to achieve this heat output.



Specific Heat Output, W/m²

-  The design floor surface temperature difference should not be more than 9 °C in occupied areas, 15 °C in unoccupied areas.
-  Heat output is limited by the floor finish resistance combined with the maximum probe setting of 40 °C.
-  Temperature limits of the floor finish or its adhesive may adversely limit the design heat output.

Warranty



* Warmup® underfloor heating is guaranteed by Warmup plc (“Warmup”) to be free from defects in materials and workmanship under normal use and maintenance, and is guaranteed to remain so subject to the limitations and conditions described below. DCM-PRO is guaranteed for the LIFETIME of the floor covering under which it is fitted, except as provided below (and your attention is drawn to the exclusions listed at the end of this guarantee).

**If installed separately DCM-PRO cable is guaranteed for 10 Years.
The DCM-PRO mat is guaranteed for 5 Years.**

This Lifetime guarantee applies:

- 1 Only if the unit is registered with Warmup within 30 days after purchase. Registration can be completed online at www.warmup.co.uk. In the event of a claim, proof of purchase is required, so keep your invoice and receipt - such invoice and receipt should state the exact model that has been purchased;
- 2 Only if the heating system has been earthed and protected by a Residual Current Device (RCD/RCBO) at all times.



All Warmup warranties are voided if the floor covering over Warmup heating cable(s) are damaged, lifted, replaced, repaired or covered with subsequent layers of flooring. The warranty period begins on the date of purchase. During the period of the guarantee Warmup will arrange for the heating system to be repaired or (at its discretion) have parts replaced free of charge or issue a refund for the product only. The cost of the repair or replacement is your only remedy under this guarantee which does not affect your statutory rights.

Such cost does not extend to any cost other than direct cost of repair or replacement by Warmup and does not extend to costs of relaying, replacing or repairing any floor covering or floor. If the system fails due to damage caused during installation or tiling, this guarantee does not apply. It is therefore important to check that the system is working (as specified in the installation manual) prior to tiling.

WARMUP PLC SHALL IN NO EVENT BE LIABLE FOR INCIDENTAL OR CONSEQUENTIAL DAMAGES, INCLUDING BUT NOT LIMITED TO EXTRA UTILITY EXPENSES OR DAMAGES TO PROPERTY.

Warmup plc is not responsible for:

- 1 Damage or repairs required as a consequence of faulty installation or application.
- 2 Damage as a result of floods, fires, winds, lightning, accidents, corrosive atmosphere or other conditions beyond the control of Warmup plc.
- 3 Use of components or accessories not compatible with this unit.
- 4 Products installed outside of any country or territory within which Warmup operates.
- 5 Normal maintenance as described in the installation and operating manual, such as cleaning thermostat.
- 6 Parts not supplied or designated by Warmup.
- 7 Damage or repairs required as a result of any improper use, maintenance, operation or servicing.
- 8 Failure to start due to interruption and/or inadequate electrical service.
- 9 Any damage caused by frozen or broken water pipes in the event of equipment failure.
- 10 Changes in the appearance of the product that does not affect its performance.

Control card

Warning!

Radiant direct floor heating system. Risk of shock or fire



Flexible sheet heating units are installed within the floor. DO NOT penetrate with nails, screws, or similar devices. DO NOT restrict the thermal emission of the heated floor. DO NOT affix materials other than those recommended

Checklist - Installer

Is the heating system, including manufactured joints, underneath the floor covering embedded in adhesive/levelling compound?

Can you confirm that the manufactured joints and floor sensor tip, have **NOT** been taped over during installation?

Model	Location	Power	System resistance			Insulation resistance test	Sensor resistance
			Before	During	After		

Installer name, company:

Installer signed: Date:

Checklist - Electrician

Is the heating system protected by a dedicated 30 mA RCD/RCBO or an existing RCD/RCBO? **Time delay RCD's must not be used.**

Is the system separated from the power supply by suitably rated circuit breaker that disconnects all poles with at least 3 mm contact separation, for example, MCB's, RCBO's or fuses?

Model	Location	Power	System resistance		Insulation resistance test	Sensor resistance
			Pre-connection			

Electrician name, company

Electrician signed Date:

This form must be completed as part of the Warmup Guarantee. Ensure that the resistance values are as per the instruction manual. This control card, a layout plan and EcoDesign compliance information card must be left permanently fixed near the consumer unit.

Warmup plc T: 0345 345 2288 F: 0345 345 2299 www.warmup.co.uk
 704 Tudor Estate ■ Abbey Road ■ London ■ NW10 7UW ■ UK
Warmup GmbH ■ Ottostraße 3 ■ 27793 Wildeshausen ■ DE



EcoDesign compliance information card

This product is an electric underfloor local space heater and, in order to be compliant with the mandatory EcoDesign requirements set out in Commission Regulation (EU) 2024/1103, needs to be complemented with a control providing at least the following control functions:

Type of heat output/room temperature control (one of)

TD	Electronic room temperature control plus day timer (Minimum of 3 control options required)	<input type="checkbox"/>
TW	Electronic room temperature control plus week timer (Minimum of 1 control options required)	<input type="checkbox"/>

Other control options (multiple selections possible)

f2	Open window detection	<input type="checkbox"/>
f3	Distance control option	<input type="checkbox"/>
f4	Adaptive start control	<input type="checkbox"/>
f7	Self-learning functionality	<input type="checkbox"/>
f8	Control accuracy	<input type="checkbox"/>

Room temperature control power consumption

The control must have an off mode, standby mode or both and must comply where the function exists

In off mode	$P_o \leq 0.5W$	<input type="checkbox"/>
In standby mode (select one)	$P_{sm} \leq 0.5W$	<input type="checkbox"/>
	$P_{dsm} \leq 1.0W$ (if control has an active display in standby mode)	<input type="checkbox"/>
	$P_{nsm} \leq 2.0W$ (if control has a network connection in standby mode)	<input type="checkbox"/>
In idle mode (select one)	$P_{idle} \leq 1.0W$	<input type="checkbox"/>
	$P_{nidle} \leq 3.0W$ (if control has a network connection)	<input type="checkbox"/>

The following Warmup thermostats include these control function codes and power consumptions:

Thermostat model	Control function code	Power consumption					
		Off mode	Standby mode			Idle mode	
		$P_o \leq 0.5W$	$P_{sm} \leq 0.5W$	$P_{dsm} \leq 1.0W$	$P_{nsm} \leq 2.0W$	$P_{idle} \leq 1.0W$	$P_{nidle} \leq 3.0W$
Tempo	TW (f4/f8)	<input checked="" type="checkbox"/>				<input checked="" type="checkbox"/>	
Element	TW (f2/f3/f4/f8)				<input checked="" type="checkbox"/>		<input checked="" type="checkbox"/>
6iE	TW (f2/f3/f4/f8)	<input checked="" type="checkbox"/>			<input checked="" type="checkbox"/>		<input checked="" type="checkbox"/>

For the combined heat output of all local electric space heaters attached to an individual control please refer to the technical specification page of this manual.

If using alternative thermostats, you must complete the above card according to the definitions of the control function codes specified in Regulation (EU) 2024/1103 to ensure compatibility with this local electric space heater.

Only functions that are active after the control has been commissioned can be declared and used for compliance.

Control function codes

Required to be in manual as part Regulation (EU) 2024/1103

		Code of temperature control (TC)	Control functions							
			f1	f2	f3	f4	f5	f6	f7	f8
Type of temperature control	Single stage, no temperature control	NC								
	Two or more manual stages, no temperature control	TX								
	Mechanic thermostat room temperature control	TM								
	Electronic room temperature control	TE								
	Electronic room temperature control plus day timer	TD								
	Electronic room temperature control plus week timer	TW								
Control functions	Presence detection		1							
	Open window detection			2						
	Distance control option				3					
	Adaptive start control					4				
	Working time limitation						5			
	Black bulb sensor							6		
	Self-learning functionality								7	
	Control accuracy with CA < 2 Kelvin and CSD < 2 Kelvin									8



SafetyNet™ Installation Guidelines: If you make a mistake and damage the new heating system before laying the floor covering, return the damaged system to Warmup within in 30 days along with your original dated sales receipt.

WARMUP WILL REPLACE ANY PRE-TILED HEATING SYSTEM (MAXIMUM 1 SYSTEM) WITH ANOTHER HEATING SYSTEM OF THE SAME MAKE AND MODEL - FREE.

- 1 Repaired systems carry a 5 year warranty only. Under no circumstances is Warmup responsible for the repair or replacement of any tiles / floor covering which may be removed or damaged in order to affect the repair.
- 2 The SafetyNet™ Installation Guarantee does not cover any other type of damage, misuse or improper installation due to improper adhesive or subfloor conditions. Limit of one free replacement system per customer or installer.
- 3 Damage to the system that occurs after tiling, such as lifting a damaged tile once it has set, or subfloor movement causing floor damage, is not covered by the SafetyNet™ Guarantee.

Disposal information



Do not dispose with regular domestic waste! Electronic equipment must be disposed of at local collection points for waste electronic equipment in compliance with the Waste Electrical and Electronic Equipment Directive.



Warmup plc

www.warmup.co.uk

uk@warmup.com

Tel: 0345 345 2288

Fax: 0345 345 2299



**Please scan the QR code to provide
feedback on your installation**

Warmup

The WARMUP word and associated logos are trade marks.
© Warmup Plc. 2024 – Regd.™ Nos. 1257724, 4409934, 4409926,
5265707. E & OE.

Warmup plc ■ 704 Tudor Estate ■ Abbey Road ■ London ■ NW10 7UW ■ UK

Warmup GmbH ■ Ottostraße 3 ■ 27793 Wildeshausen ■ DE

Warmup - IM - DCM-PRO - V1.10 - 2024-08-22_EN